



THE INFORMATION CONTAINED IN THIS DRAWING IS THE SOLE PROPERTY OF VTE INCORPORATED. ANY REPRODUCTION IN PART OR WHOLE WITHOUT THE WRITTEN PERMISSION OF VTE INCORPORATED IS PROHIBITED.

LTR.	REVISIONS	DATE
A	ADDED MATERIAL IDENTIFIER WILDCARD	05DEC08
B	ADDED INSERT PART NUMBERS	16MAY13
C	REMOVED "H" MATERIAL	15MAY14



Ⓐ

\* MATERIAL IDENTIFIER Ⓒ  
V=95 DURDMETER PVC



STYLE 'A' GRIP INSERTS Ⓓ

PART NUMBER	COLOR	CABLE C/L HEIGHT	STYLE 'A'30		STYLE 'A'50		STYLE 'A'70		A30	A50	A70
			MIN.	MAX.	MIN.	MAX.	MIN.	MAX.			
729A30*02	RED		.36"// 9.1mm	.92"// 23.3mm	.59"// 14.9mm	.89"// 22.6mm	.64"// 16.3mm	.81"// 20.6mm			
729A30*14	BLACK	CABLE Ø	.300"//7.6mm		.500"//12.7mm		.700"//17.8mm		229A30	229A50	229A70
729A50*02	RED	MAX									
729A50*14	BLACK	TERMINAL Ø	1.13"//28.8mm		1.13"//28.8mm		1.13"//28.8mm				
729A70*02	RED										
729A70*14	BLACK										

STYLE 'B' GRIP INSERTS

PART NUMBER	COLOR	CABLE C/L HEIGHT	STYLE 'B'30		STYLE 'B'50		STYLE 'B'70		B30	B50	B70
			FIXED	FIXED	FIXED	FIXED					
729B30*02	RED		.63"//16.0mm		.63"//16.0mm		.63"//16.0mm				
729B30*14	BLACK	CABLE Ø	.300"//7.6mm		.500"//12.7mm		.700"//17.8mm		229B30	229B50	229B70
729B50*02	RED	MAX									
729B50*14	BLACK	TERMINAL Ø	1.13"//28.8mm		1.13"//28.8mm		1.13"//28.8mm				
729B70*02	RED										
729B70*14	BLACK										

STYLE 'C' GRIP INSERTS

PART NUMBER	COLOR	CABLE C/L HEIGHT	STYLE 'C'30		STYLE 'C'50		STYLE 'C'70		C30	C50	C70
			FIXED	FIXED	FIXED	FIXED					
729C30*02	RED		.63"//16.0mm		.63"//16.0mm		.63"//16.0mm				
729C30*14	BLACK	CABLE Ø	.300"//7.6mm		.500"//12.7mm		.700"//17.8mm		229C30	229C50	229C70
729C50*02	RED	MAX									
729C50*14	BLACK	TERMINAL Ø	.60"//15.2mm		.86"//21.8mm		.98"//24.9mm				
729C70*02	RED										
729C70*14	BLACK										

TOLERANCE UNLESS OTHERWISE SPECIFIED: ±.030"/±0.8mm  
RADIAL DIAMETERS TO BE MEASURED OVER MANDRELS,  
RING GAGES OR PIN GAGES OF SUITABLE SIZE

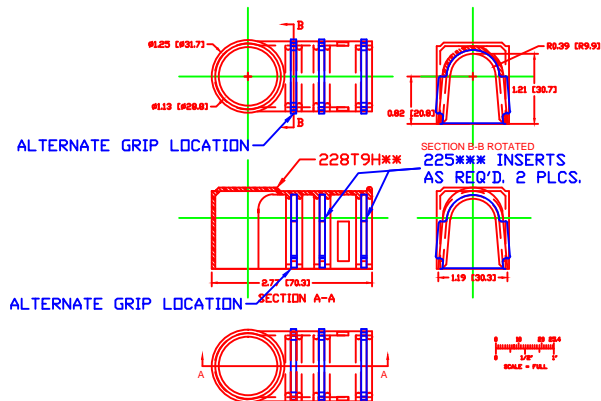

		<b>VTE Incorporated</b> 5437 Robinson Road, P.O. Box 790 Pellston, Michigan 49769 Telephone: 1-800-527-9256, 231-539-8000 FAX: 231-539-0914	
		REF: 228T9 & 229***	DATE: 00-00-98
TITLE: TUNNEL CAP INSULATOR			SCALE:
MATERIAL:		PART NO.	
COLOR: CHARTED	DRG CLASS: ***	729 SERIES	